

Lucinda Chair





ASSEMBLY INSTRUCTIONS





JOON LOLOI

ASSEMBLY INSTRUCTIONS: BEFORE BEGINNING

Read these instructions carefully and keep for future reference. Refer to parts inventory for guidance, and ensure you have all pieces before starting. When assembling, place all parts on a soft, clean, and flat surface such as a carpet to prevent scratches.

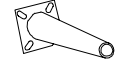
1. Carefully unpack and position the item on a clean, non-marring surface to assemble.
2. Read these Assembly Instructions from beginning to end before starting to assemble.
3. Take an inventory of the required parts to ensure all are available.
4. To prevent accidental choking hazards, keep all packing materials away from small children.
5. Only tighten hardware until ALL hardware are fully engaged on their locations. Over-tighten bolts will damage the bolt threads.
6. Use only factory provided hardware to assemble. Unapproved hardware can damage product or jeopardize the structural integrity of the product.
7. The use of power tool to assemble is not recommended due to high risk of over-torque, which can damage the product.

HARDWARE INVENTORY				
ID	IMAGE	DESCRIPTION	SIZE	QTY
A		ALLEN BOLT	M8 X 30	12
B		ALLEN WRENCH	M5	1
C		SPRING WASHER	M8 X 18	12
D		WASHER	M8 X 22	12

PARTS INVENTORY			
ID	IMAGE	DESCRIPTION	QTY
E		FRONT LEG	1
F		FRONT LEG	1
G		BACK LEG	1
H		BACK LEG	1
I		CHAIR BODY	1

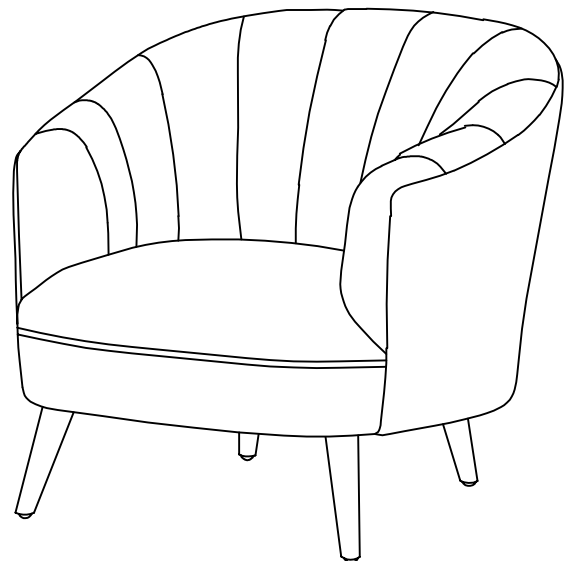

JOON LOLOI

STEP 1

Rotate chair so that the back of the chair is resting on the floor. Then place a front leg on the front of the chair, lining up the leg with the corresponding holes on the bottom of the chair. Then, starting with the WASHER (D), next the SPRING WASHER (C), and threading the BOLT (A) through both. Next, thread BOLT (A) through both holes in the leg and chair and screw the bolt to secure the leg to the bottom of the chair. Repeat this step until there are no longer any legs, BOLTS (A), WASHERS (C), and SPRING WASHERS (B) and all legs have been attached to the chair.

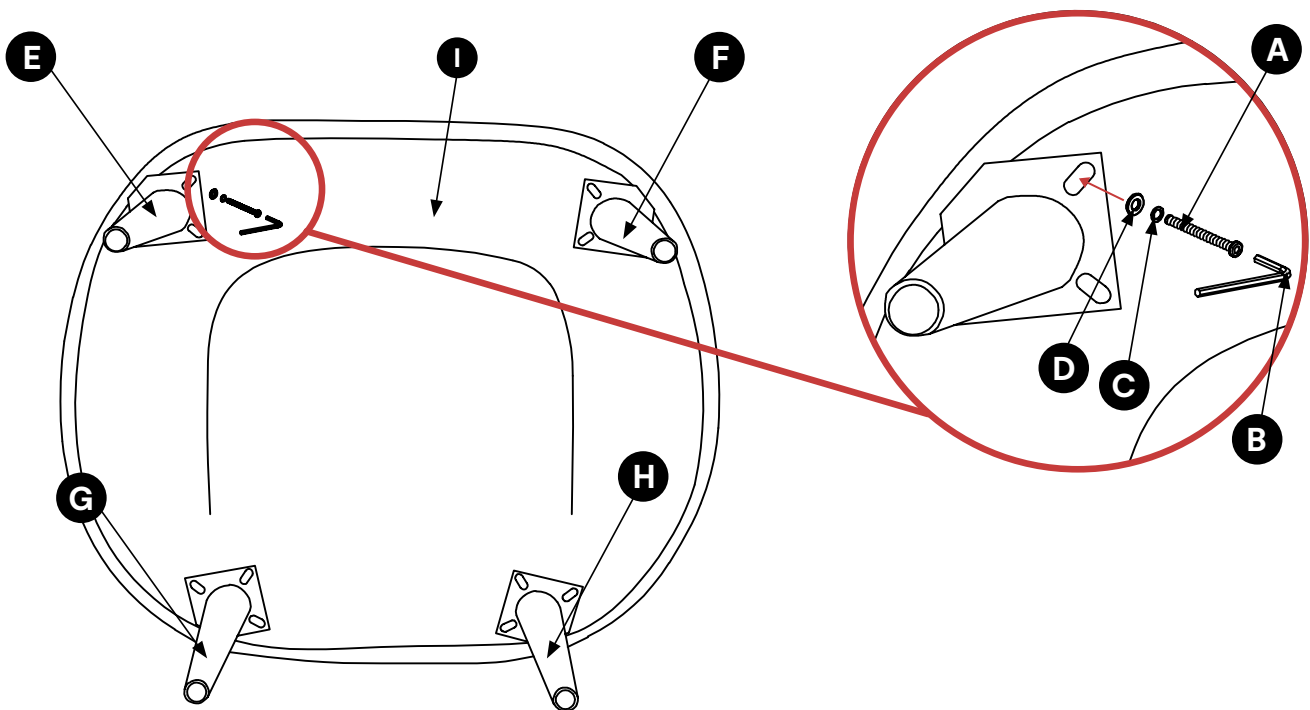

STEP 2

Your assembly is complete!

