

# Alin Table Lamp

---

LIGHTING

# JOON LOLOI

## ⚠ SAFETY INSTRUCTIONS

These instructions are provided for your safety. It is very important that they are read carefully and completely before beginning the assembly and installation of this lamp. This lamp has been rated for up to one (1) 100-watt maximum standard incandescent light bulb (not included). To avoid the risk of fire, do not exceed the recommended wattage. This lamp is meant for indoor use. DRY LOCATION ONLY. **SAVE THESE INSTRUCTIONS.**

## ⚠ WARNING

**TO REDUCE THE RISK OF FIRE, ELECTRICAL SHOCK OR PERSONAL INJURY, ALWAYS TURN OFF AND UNPLUG THE LAMP AND ALLOW IT TO COOL PRIOR TO REPLACING THE LIGHT BULB.**

**DO NOT TOUCH BULB WHEN THE LAMP IS TURNED ON. DO NOT LOOK DIRECTLY AT LIT BULB.**

**KEEP FLAMMABLE MATERIALS AWAY FROM LIT BULB.**

## ASSEMBLY INSTRUCTIONS

Remove all parts and hardware from box along with any plastic protective packaging.

Do not discard any contents until after assembly is complete to avoid accidentally discarding small parts or hardware.

PARTS INVENTORY		
ID	DESCRIPTION	QTY
<b>A</b>	FINIAL	1
<b>B</b>	LAMP SHADE	1
<b>C</b>	HARP	1
<b>D</b>	SADDLE	1
<b>E</b>	LAMP BODY	1
<b>F</b>	RETAINER	1
<b>G</b>	CORD AND PLUG	1

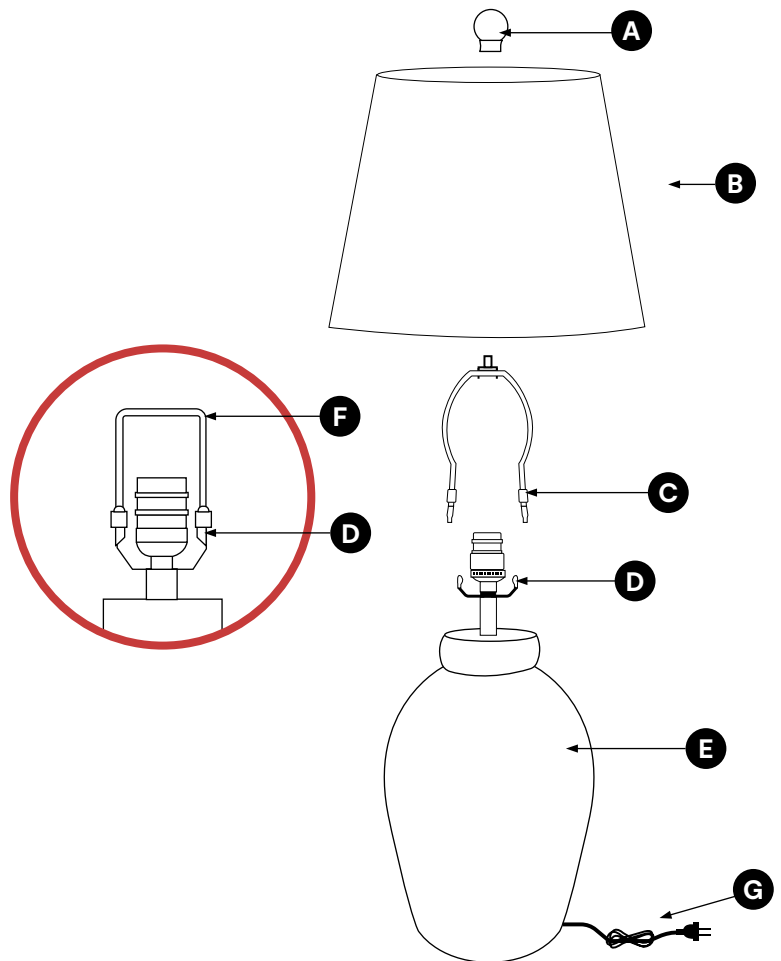

*\*The drawing shown is for illustration purpose only, and may vary from actual product.*

# JOON LOLOI

---

## STEP 1

Lift the caps of **RETAINER (F)** and remove the **RETAINER (F)** from the **SADDLE (D)**.

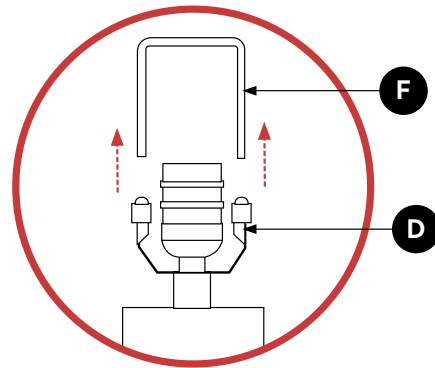

## STEP 2

Insert the **HARP (C)** into the **SADDLE (D)** and lower the harp caps until they cover the two-pronged **SADDLE (D)**.

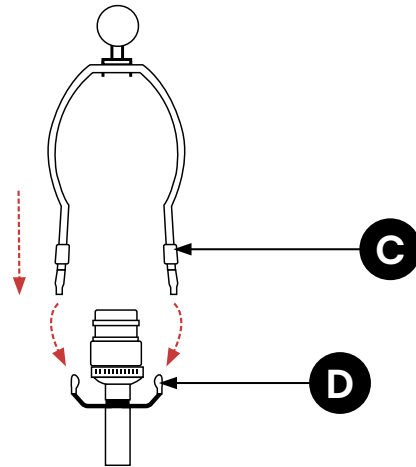

## STEP 3

Unscrew the **FINIAL (A)** from the harp top. Place the **LAMP SHADE (B)** over the assembled **HARP (C)**, making sure the harp top extends through the hole at the top of the **LAMP SHADE (B)**. Attach the **FINIAL (A)** onto the harp top and tighten to secure the **LAMP SHADE (B)**.

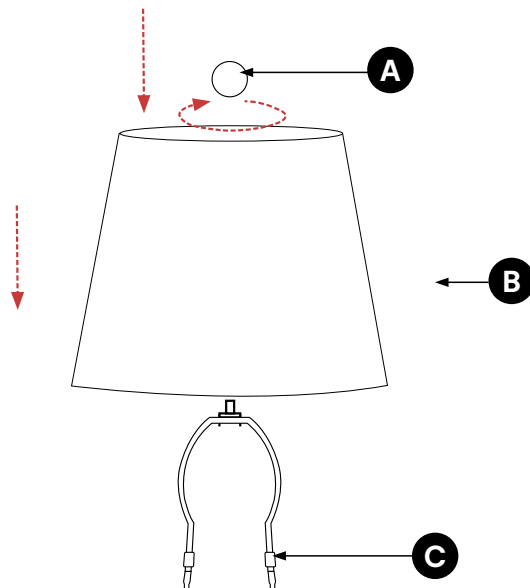
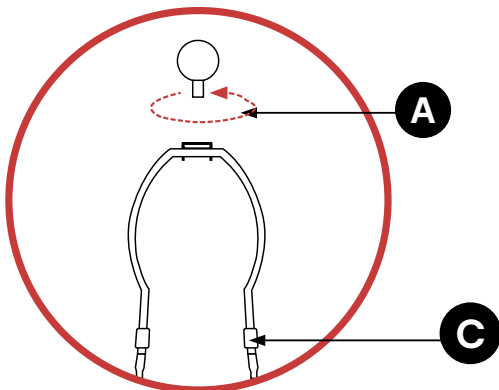

# JOON LOLOI

---

## STEP 4

Insert one **(1)** 100-watt maximum standard incandescent light bulb (not included) into the socket and screw in the light bulb.

**DO NOT EXCEED THE SPECIFIED WATTAGE.**

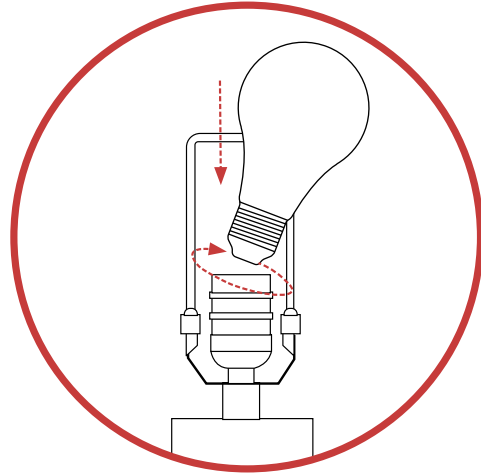

## STEP 5

Plug the **CORD (G)** of the lamp into the proper electrical outlet and test this lamp. Now your assembly is complete.

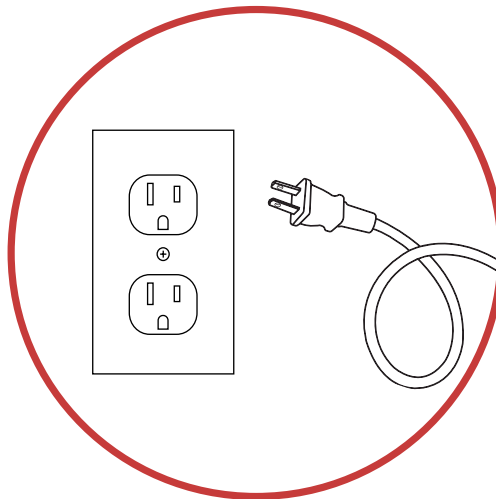

## CARE INSTRUCTIONS

Wipe clean with a soft, dry cloth or static duster.

Always avoid the use of harsh chemicals or abrasive cleaners as they may cause damage to the lamp's finish.